

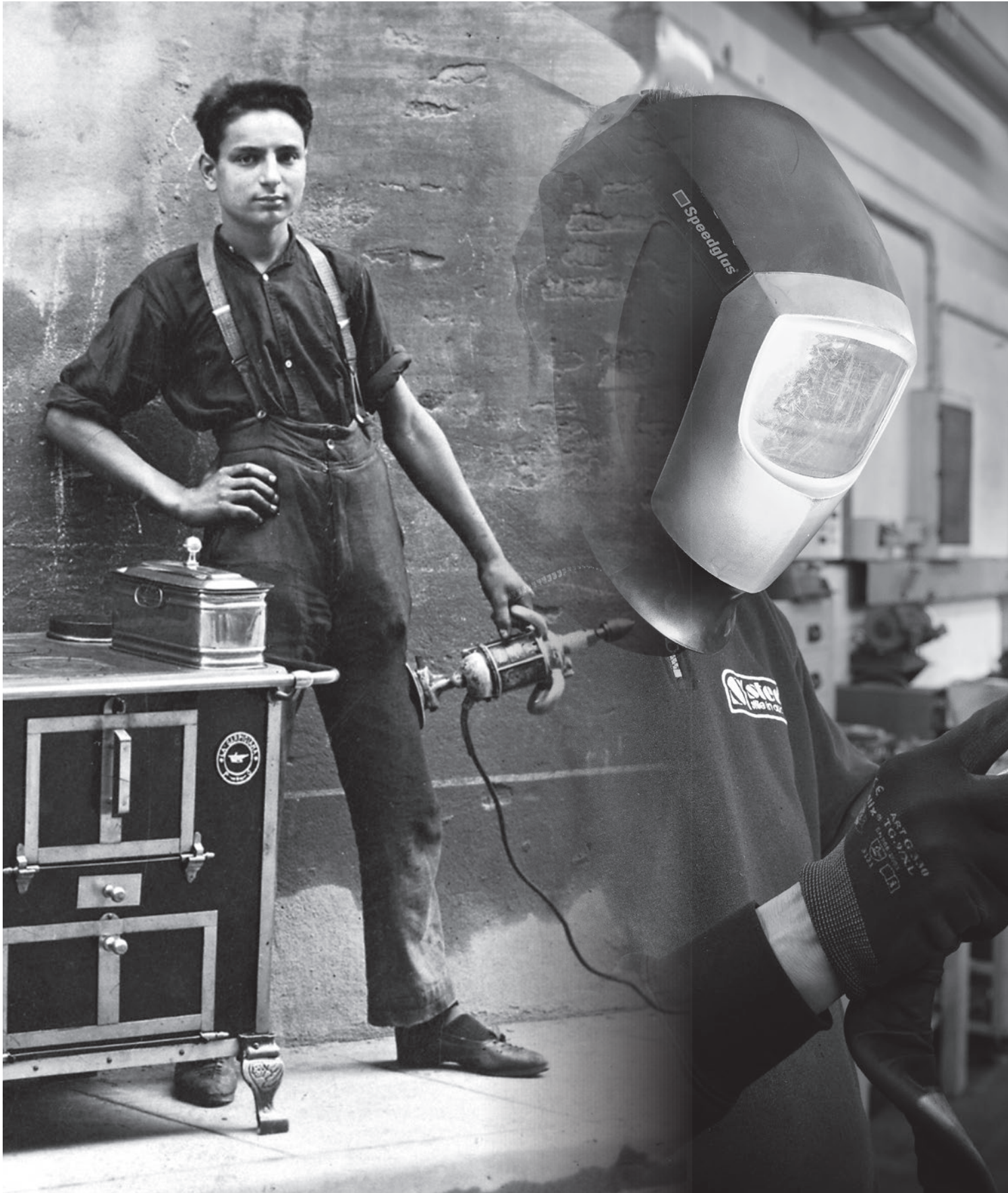



OUTDOOR
LIFESTYLE







Azienda familiare con sede a Carpi (Modena), Steel nasce nel 1999 grazie all'intraprendenza dei fratelli Po che hanno saputo trasferire nel segmento delle cucine professionali l'esperienza e la notorietà del capostipite Angelo Po, autentico pioniere del settore, che avviò la sua attività di artigiano dell'acciaio nel 1922 con le prime cucine a legna, affermandosi poi nella produzione di avanzati modelli per la ristorazione.

Steel est une société Italienne issue d'un long héritage familiale. Située à CARPI à coté de Bologne et créée en 1999, Steel est dirigée par la troisième génération de la famille PO impliquée dans la fabrication de matériel de cuisson. La première société artisanale créée en 1922 par Angelo Po a été précurseur dans le travail de l'Inox pour les cuisinières, puis devenu internationale elle est encore à ce jour la référence de la haute qualité dans la grande restauration professionnelle.

Steel is an Italian company with a long family heritage. Situated in Carpi near Bologna and founded in 1999, it is owned and run by the Po family, who are the third generation to be involved in the production of range cooking equipment. The original company was set up by Angelo Po in 1922 and his craftsmanship in stainless steel helped produce the first hand made stoves and later, the production of high-quality appliances for restaurants.

Das Unternehmen Steel wurde 1999 gegründet mit dem Ziel, semiprofessionelle Hausgeräte zu entwickeln und zu vermarkten. Die Inhaberfamilie kann auf eine lange Tradition zurückblicken. Bereits im Jahr 1922 gründete Angelo Po in Carpi nahe Bologna eine kleine Schmiede. Standen zunächst verschiedene Schmiedearbeiten und Reparaturen von Holz- und Kohleöfen auf dem Programm, so leitete 1927 die Vorstellung des ersten eigenen Kochherdes die Entwicklung zur Herd- und Küchenmanufaktur ein.





Oggi Steel si distingue per una vasta gamma di cucine in acciaio da esterno che permettono di trasferirsi all'aria aperta nei mesi estivi, senza compromessi. Barbecue, unità di cottura e moduli per la preparazione e conservazione dei cibi, interamente in acciaio inox per garantire la massima affidabilità, praticità di utilizzo e lunga durata.

Aujourd'hui Steel est au premier plan de la fabrication d'une large gamme de cuisine d'extérieur en Inox de haute qualité offrant du meuble de rangement au meuble évier en passant par les meubles d'angles toutes les possibilités de se personnaliser une cuisine d'extérieur à même de vous faire profiter pleinement des joies de ce nouvel art de vivre. Sans oublier l'essentiel de nos productions, des barbecues en Inox très puissants, des planchas et de nombreux accessoires (grill viande, tournebroche, pierre à pizza...) qui vous raviront.

Today Steel is in the forefront of the production of a wide range of stainless steel kitchen for outdoor, allowing to enjoy the open air spaces, uncompromisingly. Completely stainless steel barbecues, cook-units, and units for food preparation and storage to ensure reliability, practical use and longevity.

Heute ist Steel führend bei der Herstellung von modularen Edelstahlküchen für den Outdoor-Bereich. Mit unseren Modulküchen bieten wir vielfache Möglichkeiten, den Wunsch nach einer individuellen und attraktiven Lösung für die Aussenküche in die Tat umzusetzen. Neben Grills stehen Gaskochstellen, Tische, Spülen und Kühlgeräte zur Verfügung.

OUTDOOR KITCHENS



Outdoor kitchen 3,40 mt – 70 cm refrigerator, 90 cm bbq/oven – 90 cm sink unit – 90 cm working table





Outdoor kitchen 4,10 mt – 70 cm working table – 90 cm bbq/oven – 70 cm refrigerator – 90 cm cookunit – 90 cm sink unit





Outdoor kitchen details



Outdoor kitchen detail cookunit

OUTDOOR KITCHENS

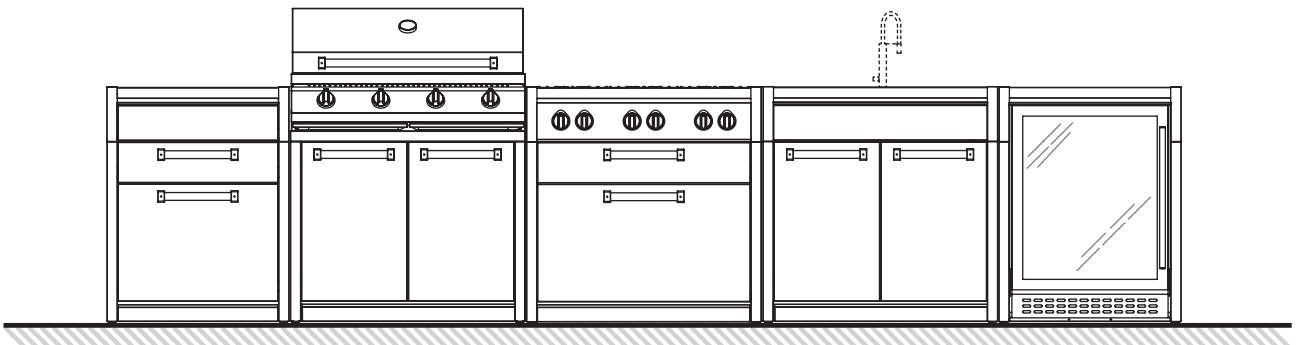
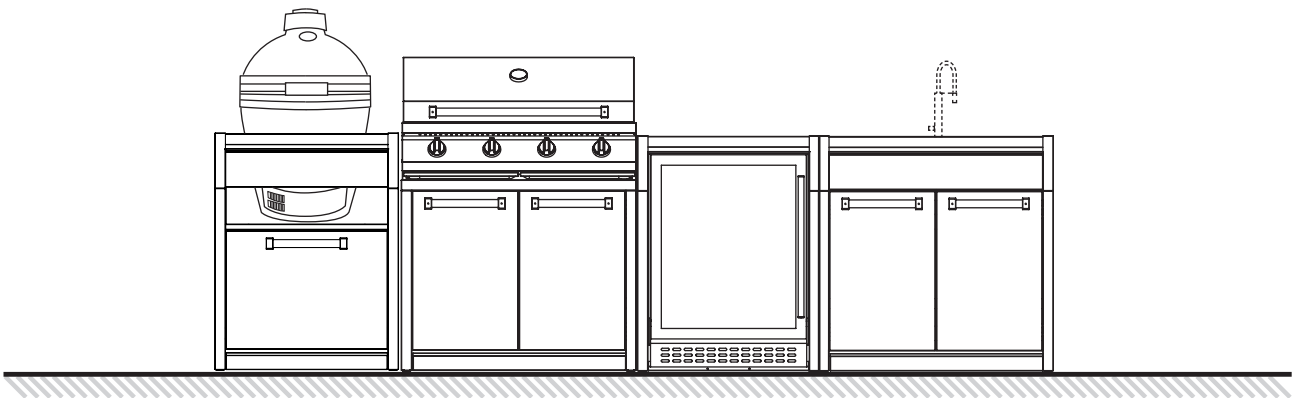
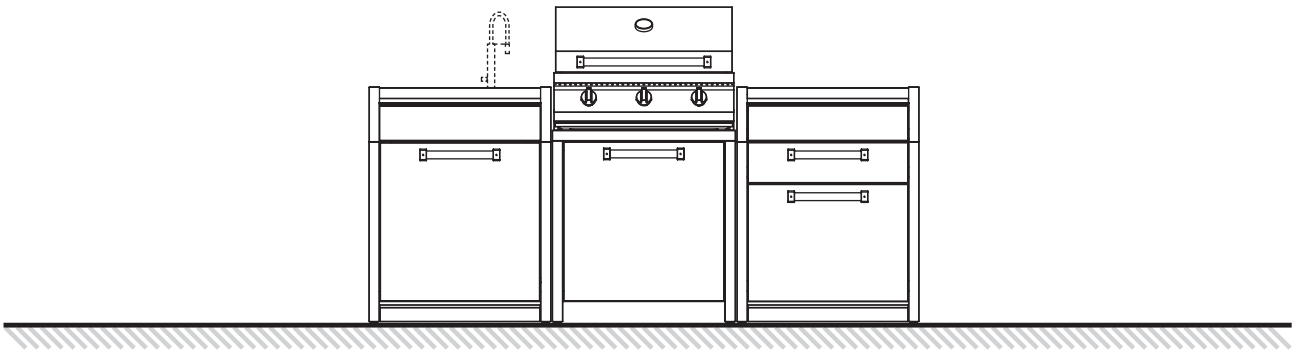



Outdoor kitchen 2,8 mt – 70 cm sink unit – 70 cm bbq/oven – 70 cm BGE stand – 70 cm refrigerator

La comodità della cucina di casa, la libertà degli spazi aperti. Le cucine outdoor di Steel, grazie alla loro modularità, possono essere costruite seguendo ogni esigenza di spazio e di utilizzo. Combinando elementi per la cottura, ampi vani di stoccaggio, sistemi di conservazione e di preparazione, è possibile ricreare all'esterno tutta la comodità della propria cucina, senza scendere ai compromessi che le mura di casa ci impongono.

Le confort d'une cuisine adaptée à vos besoins, la liberté de composer et créer votre propre espace d'art de vivre en extérieur. La modularité offerte par les composants Steel vous autorise de concevoir et construire. L'espace que vous voulez y consacrer selon vos goûts et vos contraintes. Vous pouvez combiner un meuble de préparation avec un élément de cuisson, un élément de réfrigération, une plancha... tout vous est autorisé... vous recevez les meubles montés vous n'avez plus qu'à les juxtaposer. Vous pouvez en changer les dispositions pour un meilleur confort. Si vous déménagez vous pouvez même partir avec.

The comfort of your own kitchen, the freedom of wide-open spaces. Thanks to their modularity, Steel outdoor kitchen can be tailor made around your space and use needs. You can combine cooking elements, wide storage compartments, preparation and conservation units in order to recreate the comfort of your own kitchen, without compromising on spaces.

Für die Auf- und Ausrüstung einer Sommerküche stehen Module in verschiedenen Breiten zur Verfügung. Die Basis bildet ein Grill- oder Kochtisch der mit passenden Spülen und Schränken kombiniert werden kann. Durch diesen Variantenreichtum lässt sich die Küche an die jeweilige räumlichen Gegebenheiten anpassen und bleibt immer flexibel.



Outdoor kitchen 4,30 mt – 90 cm sink unit – 90 cm bbq/oven – 90 cm cookunit – 90 cm working table – 70 cm refrigerator



GREEN



Green 90 cm





Green 90 cm





Ampiezza di superfici, visione d'impatto, design pulito ed elegante. Green è la versione più esclusiva del barbecue. Il corpo in acciaio inox, le maniglie invisibili, lo rendono un oggetto intramontabile. I bruciatori in fusione di acciaio inox garantiscono potenza assoluta e le pietre ceramiche uniformità di cottura per performances da professionisti. Il ripiano in teak e il coperchio telescopico lo trasformano nella zona di appoggio perfetta, per momenti di convivialità en plein air.

L'aspect visuel est sobre, net et élégant en un mot unique. Green est la version la plus exclusive des barbecues. Son corps en acier inoxydable ses poignées invisibles en font un objet intemporel. Des brûleurs en acier de fusion très puissants, des briques ceramic indispensables pour avoir une uniformité de cuisson, apportent des performances professionnelles. L'entourage en teck, et son couvercle télescopique invite à passer de grands moments de convivialité autour de lui.

Wide surfaces, an impact look, clean and elegant design. Green is the most exclusive version of the barbecue grill. The stainless steel body and invisible handles make it a timeless object. Cast stainless steel burners for absolute power, ceramic spreaders for uniform cooking. Professional performances. The teak shelf and the telescopic lid turn it into a comfort zone for open air conviviality moments.

"Green" eröffnet Weite. Mit den seitlichen Ablageflächen aus Teak vermittelt dieser Barbecue Grill eine neue Großzügigkeit. Der Edelstahlkorpus wirkt edel umrahmt, zugleich steigt aber die Funktionalität durch das reiche Platzangebot auf den Flächen. Angeboten werden zwei unterschiedliche Modelle: Eine große Variante mit vier Gasbrennern unter der Grillfläche sowie eine kleine Variante mit zwei Brennern. Alle Funktionsteile sind aus Edelstahl oder Stahlguss ausgeführt. Im fahrbaren Edelstahlgehäuse ist Platz für eine Gasflasche, bei der großen Variante bietet eine zweite Türe zusätzlichen Stauraum.





Green 90 cm

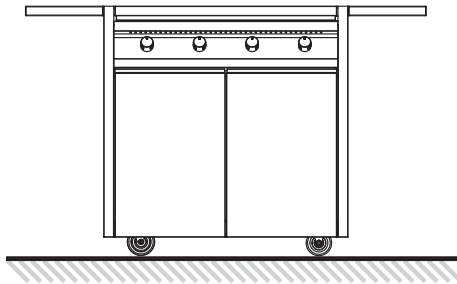

19C - 4

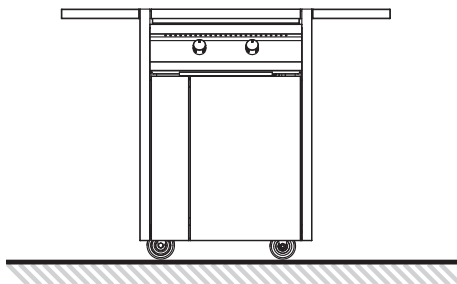
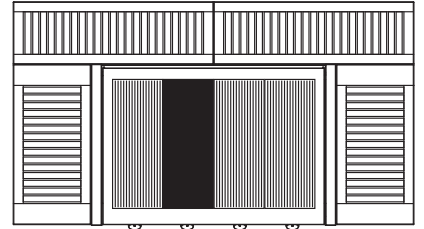

17C - 2

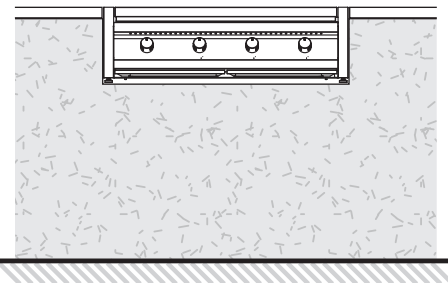
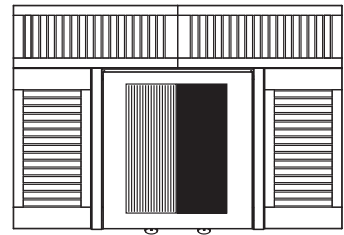

19 - 4

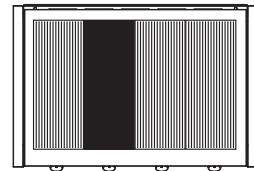



SWING



Swing 90 cm top/oven – 70 cm refrigerator – 90 cm sink unit

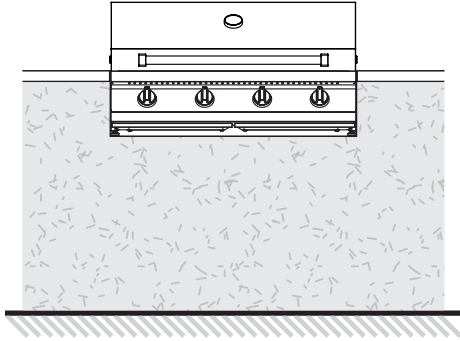

W9-4G

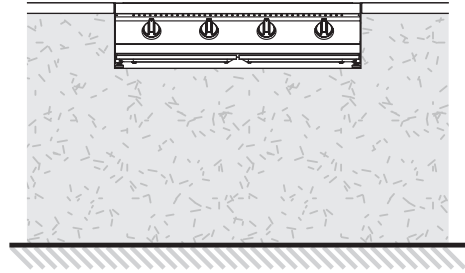

W9-4

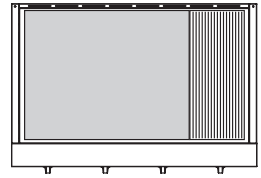

W9-4T

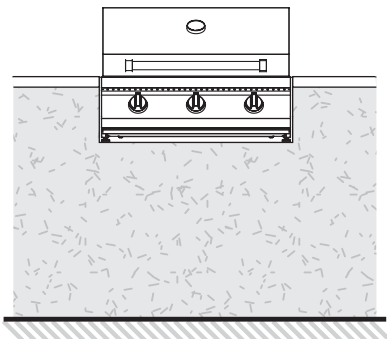
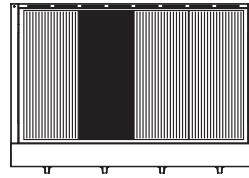
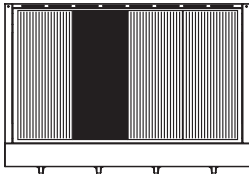

W7-3G

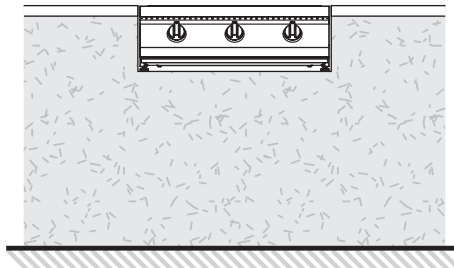

W7-3

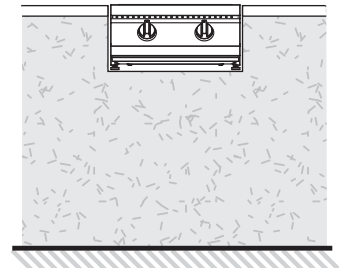

W7-3T

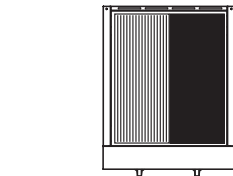
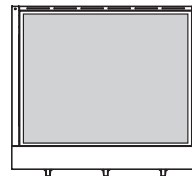
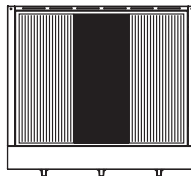
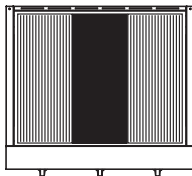

W5-2





Swing top 90 cm – 70 cm refrigerator – 90 cm sink unit



Swing top 90 cm teppanyaki

La purezza dell'acciaio, lo slancio delle forme. Swing è l'ultima generazione del barbecue: potente come i suoi bruciatori in fusione di acciaio inox, equilibrato come il bruciatore ausiliario sul ripiano laterale che permette di cucinare salse di accompagnamento o contorni, mozzafiato come il coperchio coibentato a doppio strato di acciaio inox e provvisto di termometro per la cottura a forno di carni e panificati.

The purity of the steel, soaring lines. Swing is the state-of-the-art barbecue: powerful like its cast stainless steel burners, balanced like its side burner made to prepare dressings and side dishes, breathtaking like its double stainless steel lid with thermometer for gas oven cooking of meats and bakeries.

La pureté de ses lignes élancées Swing est un barbecue ultra moderne, puissant avec ses brûleurs en fusion d'acier, équilibré. Par son brûleur latéral idéal pour préparer des sauces d'accompagnement.

Stupéfiant comme son couvercle en inox doublé avec son thermostat de contrôle du four pour les viandes et pâtisseries.

"Swing" bietet Leichtigkeit. Mit diesen Barbecue Grills wird die Essenszubereitung auf der Terrasse zum Vergnügen. Kraftvolle Brenner, grosse Grillflächen und praktische Seitenbrenner sorgen für höchstes Grillvergnügen. Stilvolles Feiern auf der Terrasse hat damit einen neuen Fixpunkt, den jeder gern sofort anerkennt.



Swing side burner



Swing 90





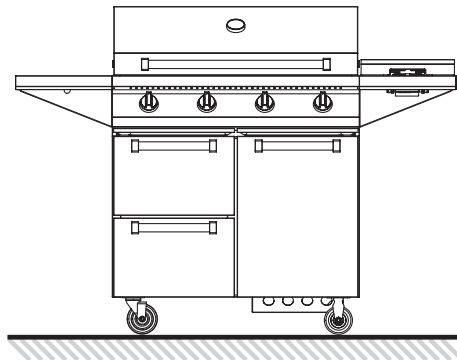

W9C-4

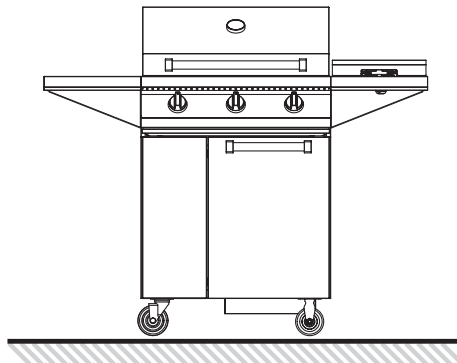
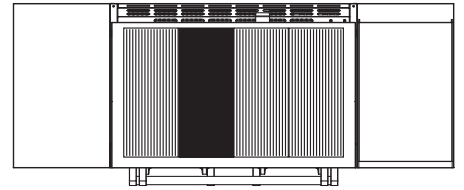

W7C-3

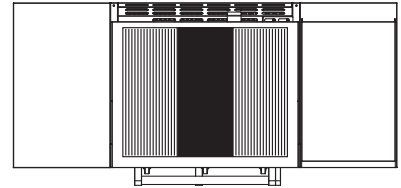

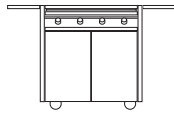
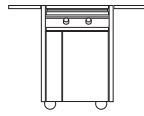
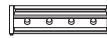
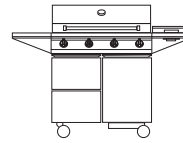
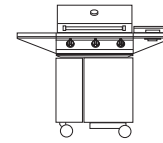
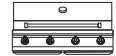



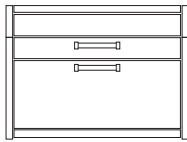
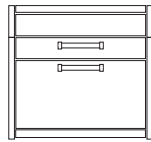
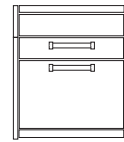
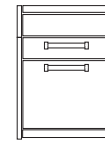
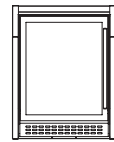





I9C-4**I7C-2****I9-4****W9C-4****W7C-3****W9-4G**

tot power kW	24,8	12,4	24,8	24,8	18,6	24,8
hot surface dm ²	36	6,2 kW	36	36	27	36
bbq burners 6,2 kW	4	2	4	4	3	4
side burner kW	no	no	no	2,9	2,9	no
burners	no	no	no	no	no	no
open griddle	3	1	3	3	2	3
flat griddle	1	1	1	1	1	1
flame deflectors	4/ceramic	2/ceramic	4/ceramic	3/s.steel	2/s.steel	3/s.steel
bottom	2 insulated drawers, 1 door	1 drawer, 1 door		2 drawers, 1 door	2 doors	no
lid	telescopic	telescopic	telescopic	double skin	double skin	double skin
rotisserie	no	no	no	set-up/automatic	set-up/automatic	set-up/automatic

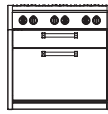
**G12C-P
WORKING TABLE****G9C-P
WORKING TABLE****G7C-P
WORKING TABLE****G4C-P
WORKING TABLE****G7FR-O
REFRIGERATOR**

width mm	1172	899	698	450	698
depth mm	599 body/625 top	599 body/625 top	599 body/625 top	599 body/625 top	599 body/625 top
height mm	898	898	898	898	898
height adjustment mm *	20	20	20	20	20
body material	s.steel Aisi 441	s.steel Aisi 441	s.steel Aisi 441	s.steel Aisi 441	s.steel Aisi 441
handles material	metal	metal	metal	metal	metal
standard trim	brushed	brushed	brushed	brushed	brushed
top material	s.steel	s.steel	s.steel	s.steel	s.steel
upper drawer	push-pull	push-pull	push-pull	push-pull	-
middle drawer	pull-out	pull-out	pull-out	pull-out	-
lower drawer	pull-out	pull-out	pull-out	pull-out	-
door(s)	-	-	-	-	glazed

W7-3G	W9-4	W7-3	W5-2	W9-4T	W7-3T	G9C-6	W4-1	G9BS-4C	G7BS-3C
									
18,6	24,8	18,6	12,4	24,8	18,6	-	2,9	24,8	18,6
27	36	27	18	36	27	-	-	36	27
3	4	3	2	4	3	no	no	4	3
no	no	no	no	no	no	no	no	no	no
no	no	no	no	no	no	6	1	no	no
2	3	2	2	1	no	no	no	3	1
1	1	1	1	1 teppanyaki 27 dm ²	1 teppanyaki 27 dm ²	no	no	1	1
2/s.steel	3/s.steel	2/s.steel	1/s.steel	1/s.steel	no	no	no	3/s.steel	2/s.steel
no	no	no	no	no	no	2 drawers	no	2 doors	1 door
double skin	no	no	no	protection	protection	no	yes	double skin	double skin
set-up/ automatic	no	no	no	no	no	no	no	set-up/ automatic	set-up/ automatic

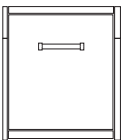
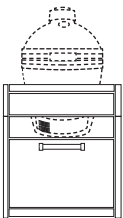
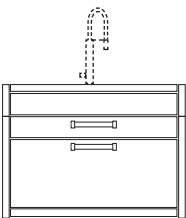
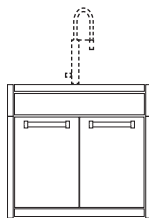
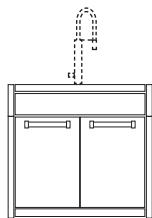
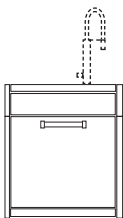
G7FR-D REFRIGERATOR	G7C-BGE WORKING TABLE	G12C-L2 SINK UNIT	G9S-L2 SINK UNIT	G9S-L1G SINK UNIT	G7S-L2 SINK UNIT
					
698	698	1172	899	899	698
599 body/625 top	599 body/625 top	599 body/625 top	599 body/625 top	599 body/625 top	599 body/625 top
898	898	898	898	898	898
20	20	20	20	20	20
s.steel Aisi 441	s.steel Aisi 441	s.steel Aisi 441	s.steel Aisi 441	s.steel Aisi 441	s.steel Aisi 441
metal	metal	metal	metal	metal	metal
brushed	brushed	brushed	brushed	brushed	brushed
s.steel	s.steel	2 bowls	2 bowls	1 big bowl	2 bowls
-	no	-	-	-	-
-	no	pull-out	-	-	-
-	pull-out	pull-out	-	-	-
solid s.steel	-	-	soft-close	soft-close	soft-close

	I9C-4	I7C-2	I9-4	W9C-4	W7C-2	W9-4G	W7-3G	W9-4	W7-3	W5-2	W9-4T	W7-3T
rotisseire				AB-GA9	AB-GA7	AB-GA9	AB-GA7					
teppanyaki 18 dm ²	AB-TY	AB-TY	AB-TY	AB-TY	AB-TY	AB-TY	AB-TY	AB-TY	AB-TY			
burners s.steel cover												
cast iron griddle	AB-PA	AB-PA	AB-PA	AB-PA	AB-PA	AB-PA	AB-PA	AB-PA	AB-PA	AB-PA	AB-PA	AB-PA
cast iron plate	AB-PD	AB-PD	AB-PD	AB-PD	AB-PD	AB-PD	AB-PD	AB-PD	AB-PD	AB-PD	AB-PD	AB-PD
ceramic spreader	AB-PR	AB-PR	AB-PR	AB-PR	AB-PR	AB-PR	AB-PR	AB-PR	AB-PR	AB-PR	AB-PR	AB-PR
s.steel spreader	AB-DX	AB-DX	AB-DX	AB-DX	AB-DX	AB-DX	AB-DX	AB-DX	AB-DX	AB-DX	AB-DX	AB-DX
tools kit	AB-KU	AB-KU	AB-KU	AB-KU	AB-KU	AB-KU	AB-KU	AB-KU	AB-KU	AB-KU	AB-KU	AB-KU
chrome water tap												
nickel water tap												
hpl chopping board												
pvc cover	AB-CUG	AB-CU	AB-CU	AB-CU	AB-CU							

	G9BS-4C	G7BS-3C	G9C-6W	G12C-L2	G9S-L2	G9S-L1G	G7S-L2	G12C-P	G9C-P	G7C-P	G7FR-O	G7FR-D
rotisseire	AB-GA9	AB-GA7										
teppanyaki 18 dm ²	AB-TY	AB-TY										
burners s.steel cover			SA-CG									
cast iron griddle	AB-PA	AB-PA										
cast iron plate	AB-PD	AB-PD										
ceramic spreader	AB-PR	AB-PR										
s.steel spreader	AB-DX	AB-DX										
tools kit	AB-KU	AB-KU										
chrome water tap			MPC	MPC	MPC	MPC	MPC					
nickel water tap			MPX	MPX	MPX	MPX	MPX					
hpl chopping board								SA-HPL12	SA-HPL9	SA-HPL7	SA-HPL7	SA-HPL7
pvc cover												



STEEL SRL
 Via dell'Agricoltura 21
 41012 Carpi (Mo) - Italy
 T. +39 059 645180
steel@steel-cucine.com

www.steel-cucine.com